

Module 5 : Directional Overcurrent Protection

Lecture 18 : Directional Overcurrent Relaying

Objectives

In this lecture we will learn

- The discrimination problem in a radial system with multiple sources and parallel paths.
- Overcurrent relays with directional feature improves its selectivity.
- The operation of 30° directional unit with voltage as reference phasor.
- Voltage polarization and current polarization in earth fault relays.

18.1 Necessity

In the overcurrent protection scheme considered in previous lectures, we had implicitly assumed that,

1. System is radial.
2. There is a single source.

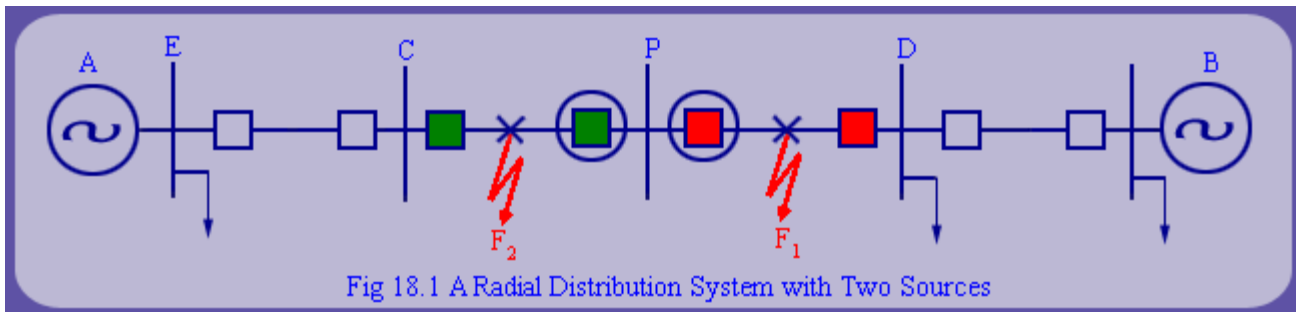

This is quite true for traditional distribution systems but it does not hold true for sub-transmission or transmission system with multiple sources. Fig 18.1 shows a system which is radial but it has two sources connected to it. If relays for protection are installed only at one end of transmission line say towards source A end, it is obvious that after opening of relay in red, the fault will continue to be fed from source B. Hence, relays are also installed at other end of line to detect fault and disconnect transmission line from the other end as well. Similar situation will exist even for a single source system if parallel paths exist (fig 18.2). Hence, system which have multiple paths to source require relays at both ends. However, installing relays at both ends does not provide a complete relaying solution. To understand the reason, consider the action of red relay in fig 18.1 with respect to two likely faults F_1 and F_2 .

If the fault is at F_1 then it is responsibility of red relays to open. If fault is at F_2 , then it is the green relays which should trip the line. However, it is quite likely that for fault F_2 , the

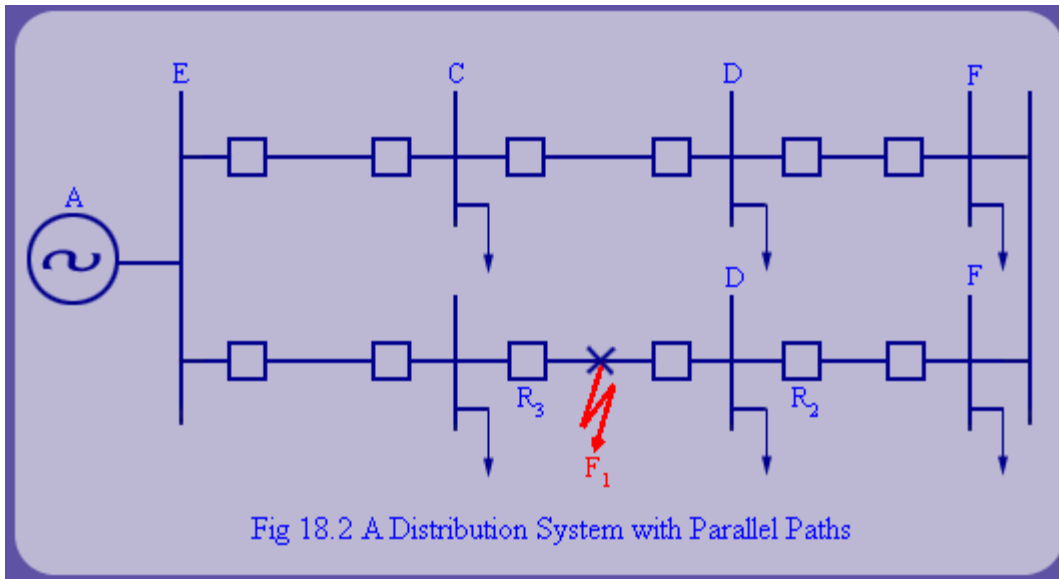

Fig 18.2 A Distribution System with Parallel Paths

circled red relay may trip before circled green relay opens to disconnect feed from the source B, the reason being that both relays are subjected to same fault current.

In other words, circled red relay competes with circled green relay to clear fault. Opening of circled red relay unnecessarily causes loss of service to load at bus P and it should be classified as wrong operation.



18.1 Necessity (contd..)

To overcome this limitation, the relay element has to be provided with additional discrimination feature to distinguish between faults that it should respond to, and others that it should not respond to. Further, this 'selectivity' will not be sufficient if it is based upon magnitude of pick up current (or fault currents). In the previous lectures, we had used time discrimination to provide selectivity. From the fig 18.3, it is apparent that such discrimination will hold between relay sequences $R_1 \rightarrow R_3 \rightarrow R_5$ and $R_6 \rightarrow R_4 \rightarrow R_2$.

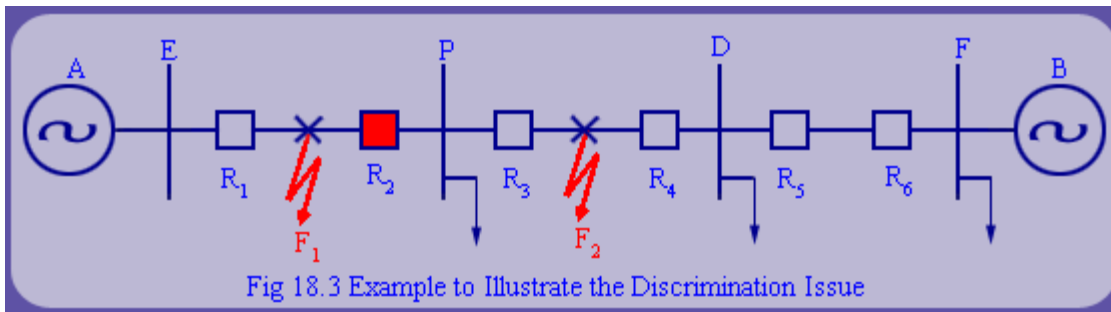

Fig 18.3 Example to Illustrate the Discrimination Issue

However, it is not possible to provide such time discrimination between relays like R_2 and R_3 . Now consider two possible fault locations with respect to relay R_3 as shown in fig 18.4. The relay R_2 should operate if fault is at F_1 because it is on primary feeder but not behind i.e. at F_2 . With polarity of CT connection as shown in fig 18.5, it is apparent that for fault F_1 current I_1 seen by the relay lags V_p by 90 degrees (fig 18.6). This is under the assumption of bolted fault and reactive nature of circuit impedance. However, when the fault is in the position F_2 , then relay current leads the bus voltage ' V_p '.

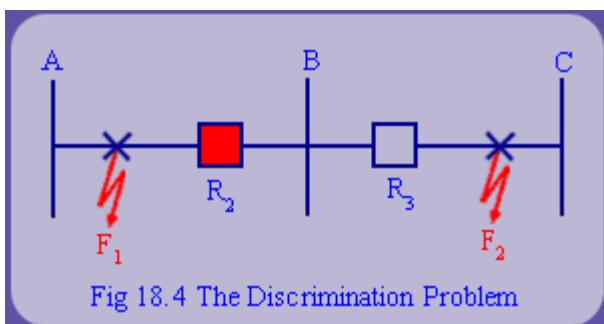

Fig 18.4 The Discrimination Problem

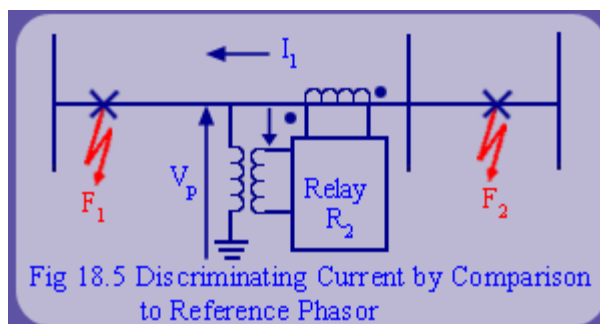
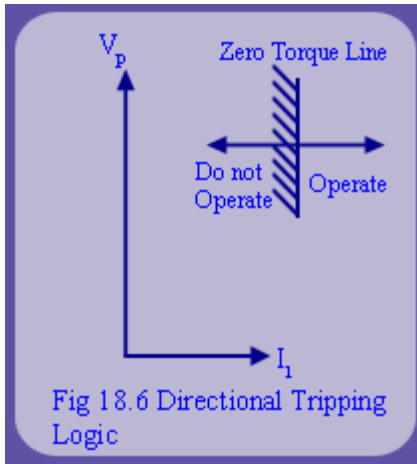

Fig 18.5 Discriminating Current by Comparison to Reference Phasor

18.2 Fundamental Principle



Thus, if we measure the bus voltage phasor V_p and compute the phase angle of relay current with respect to bus voltage, then we can use the following logic to provide selectivity. If the relay 'detects fault' and current lags $V_R (= V_p)$, then permit relay tripping. If the relay 'detects fault' and current leads $V_R (= V_p)$, then inhibit the relay tripping. The 'discrimination principle' based on phase angle comparison between a set of phasors, one of which is used as reference is called 'directional discrimination principle'. Relays with this principle are called directional relays.

For example, overcurrent relays can be made directional by adding above discrimination logic to well known overcurrent logic. Such relays are called as directional overcurrent relays. They are used in distribution system or subtransmission system where 'ring main' configuration is used to provide more reliability of service. Cost of this relaying scheme is higher than 'non-directional' overcurrent due to additional cost of VT.

We now discuss the choice of reference phasor for various type of phase and ground faults. Recall that phase relays are used to protect against phase fault (3 phase and L-L).

Now, with traditional overcurrent relays, a directional overcurrent relay can be visualized as a cascade connection of 'one directional unit' and one overcurrent unit. If the polarity of the current is appropriate, then directional unit picks up. If the current magnitude is above pickup, then the overcurrent unit also picks up and when both units pickup, the trip coil is energized and CB tripping is ensured. In a numerical relay, this can be programmed by a simple 'AND' logic.

Any fault involving ground is called a ground fault. Traditionally, three phase relays and one ground relay have been used to protect a feeder or a transmission line. However, in a numerical relay, all these functions can be integrated into a single relay which acquires 3-phase voltages and 3-phase currents.

Design of Directional Units for Phase Fault

Let us first consider, a three phase fault. In this case, choice of the reference phasor can be the phase voltage itself. For a purely reactive circuit, the fault current in the correct direction lags the reference phasor by 90° . With respect to reference phase ' V_a ', we can draw operating line (also called as zero torque line due to legacy of electromechanical relays) which separates the plane into two regions marked as 'operate' and 'Do not operate'. If the fault is in the operating region, then I_a lags V_a and we issue trip decision. In case, fault is behind the relay, the fault current leads V_a and hence lies in the "do not operate" region.

18.2 Fundamental Principle

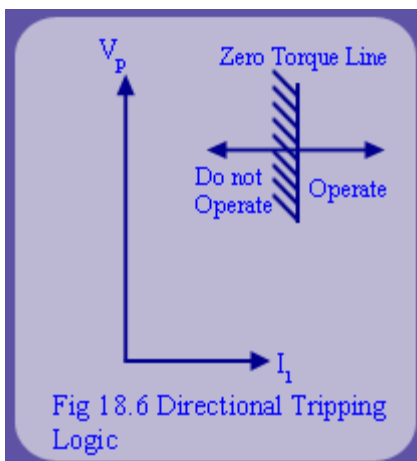

Thus, if we measure the bus voltage phasor V_p and compute the phase angle of relay current with respect to bus voltage, then we can use the following logic to provide selectivity. If the relay 'detects fault' and current lags $V_R (= V_p)$, then permit relay tripping. If the relay 'detects fault' and current leads $V_R (= V_p)$, then inhibit the relay tripping. The 'discrimination principle' based on phase angle comparison between a set of phasors, one of which is used as reference is called 'directional discrimination principle'. Relays with this principle are called directional relays.

For example, overcurrent relays can be made directional by adding above discrimination logic to well known overcurrent logic. Such relays are called as directional overcurrent relays. They are used in distribution system or subtransmission system where 'ring main' configuration is used to provide more reliability of service. Cost of this relaying scheme is higher than 'non-directional' overcurrent due to additional cost of VT.

We now discuss the choice of reference phasor for various type of phase and ground faults. Recall that phase relays are used to protect against phase fault (3 phase and L-L).

Now, with traditional overcurrent relays, a directional overcurrent relay can be visualized as a cascade connection of 'one directional unit' and one overcurrent unit. If the polarity of the current is appropriate, then directional unit picks up. If the current magnitude is above pickup, then the overcurrent unit also picks up and when both units pickup, the trip coil is energized and CB tripping is ensured. In a numerical relay, this can be programmed by a simple 'AND' logic.

Any fault involving ground is called a ground fault. Traditionally, three phase relays and one ground relay have been used to protect a feeder or a transmission line. However, in a numerical relay, all these functions can be integrated into a single relay which acquires 3-phase voltages and 3-phase currents.

Design of Directional Units for Phase Fault

Let us first consider, a three phase fault. In this case, choice of the reference phasor can be the phase voltage itself. For a purely reactive circuit, the fault current in the correct direction lags the reference phasor by 90° . With respect to reference phase ' V_a ', we can draw operating line (also called as zero torque line due to legacy of electromechanical relays) which separates the plane into two regions marked as 'operate' and 'Do not operate'. If the fault is in the operating region, then I_a lags V_a and we issue trip decision. In case, fault is behind the relay, the fault current leads V_a and hence lies in the "do not operate" region.

18.3 Phase Fault Protection

Fig 18.7 shows vector diagram and relationship between different phasors. The threshold or maximum torque line is a line perpendicular to the zero torque line. Again this terminology is because of the legacy of electromechanical relay. The threshold or maximum torque line can be placed at an angle with respect to V_a also. This does add complexity to electromechanical relay design. But same placement is a simple programming job in a numerical relay. For example, the common practice is to place the maximum torque line at an angle of 60 degrees lag or 45 degrees with respect to ' V_a ' (fig 18.8).

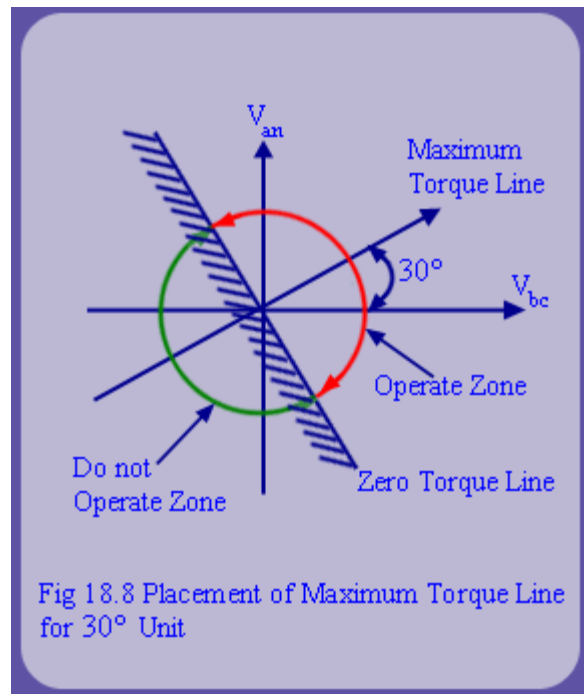
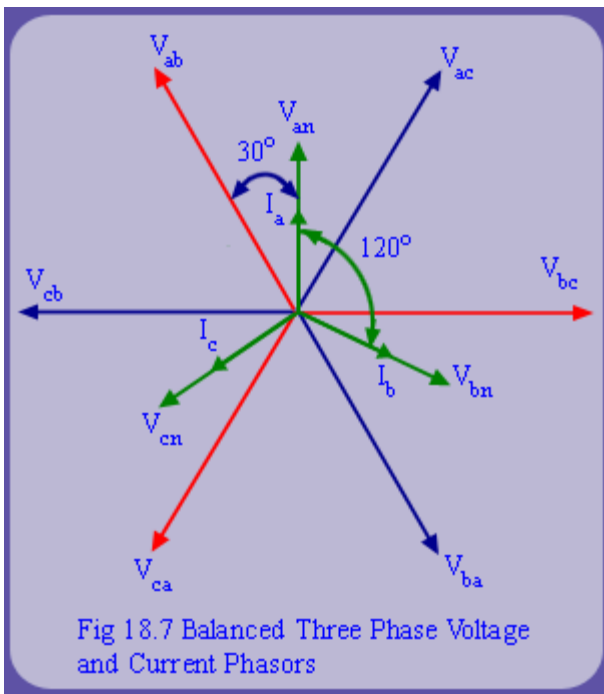

As shown in the fig 18.8, since V_{bc} is in phase quadrature with V_a , it is possible to use V_{bc} as the reference phasor and locate the maximum torque line at 30 degrees leading it. This is what traditionally practiced in legacy directional overcurrent relays (see fig 18.9). With this placement we now show that directional unit will pickup for both 3-phase and L-L faults.

Now consider a line fault involving phase 'a' and 'b'. Then, using 3-phase line model we get,
 $V_a - V_f = Z_s I_a + Z_m (-I_a) = (Z_s - Z_m) I_a = Z_1 I_a$

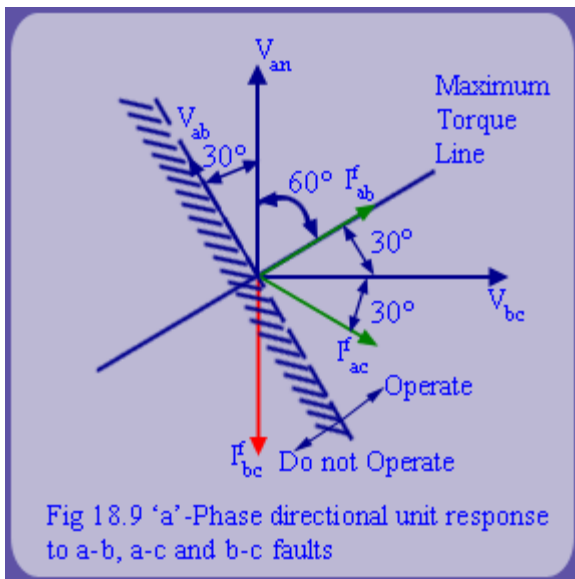

Similarly,

$$V_b - V_f = Z_s I_b + Z_m I_a = - (Z_s - Z_m) I_a = - Z_1 I_a$$

$$V_a - V_b = 2(Z_s - Z_m) I_a$$

Since, $(Z_s - Z_m) = Z_1 = Z_2$ of a feeder
$$I_a = \frac{V_a - V_b}{2Z_1}$$

If for simplicity we assume Z to be purely reactive, then from fig 18.9 we get that I_{ab}^f will be at an angle of 60 degrees lagging to V_{an} . Thus, 30° unit with V_{bc} as reference phasor will pickup on both 3-phase fault and L-L fault. For a L-L fault involving phases 'a' and 'c', V_{ac} lags V_{an} by 30° . Assuming purely reactive circuit, the phase current I_a will lag V_{bc} by 30° . As seen in the figure, I_{ac} will be again in the operate region and the directional unit will pickup. Thus, this unit (30° lead with V_{bc} as reference phasor) will pickup for all phase faults involving phase 'a'. In contrast, for L-L fault involving phases 'b' and 'c', I_{bc} will lag V_{bc} by 90° . Hence, it will lie outside the tripping region of the directional unit. Therefore, directional unit will not pickup.

To summarize, the key feature in obtaining directional discrimination is the placement of zero torque line which separates the R-X plane into two regions viz. operate and do not operate. It is apparent that in numerical relays, this placement is quite flexible and can be specified with respect to any one reference voltage phasor. This placement can be made programmable.

18.4 Earth Fault Protection

Typically, earthfaults are SLG and LLG faults. Earthfaults are distinguished by presence of zero sequence currents ' I_0 '. Since, except for unbalance, normal system operation is devoid of I_0 component, much more sensitive pickup is possible for earthfault by using component $I_0 = (I_a + I_b + I_c) / 3$ and declaring a fault if " I_0 " exceeds a threshold.

However, in a system with multiple sources or parallel paths, we will require earthfault relays to be directional. The reference phasor is sometimes called as "polarizing quantity". Also both voltage and current polarizing signals are used with ground fault relaying.

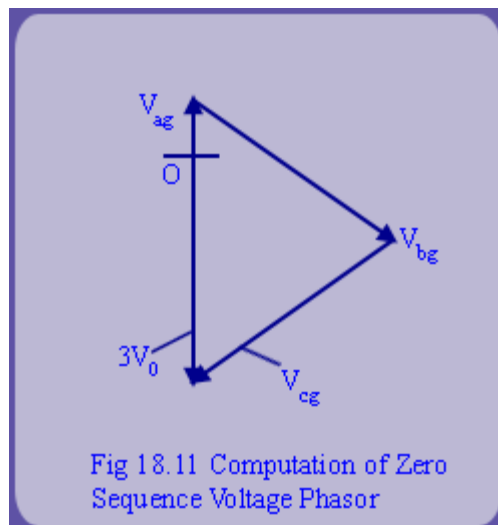
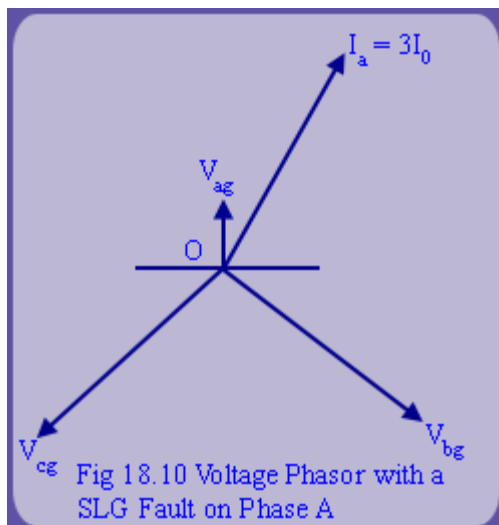

18.4 Earth Fault Protection

18.4.1 Voltage Polarization

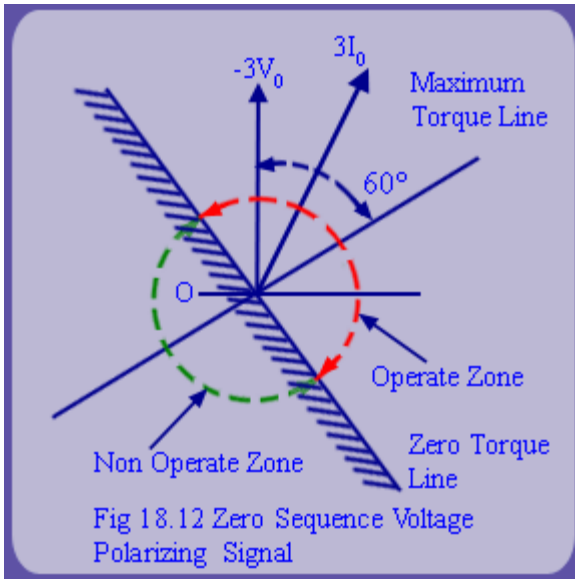

Let the system be initially unloaded and a ground fault occur on phase a. Then if $I_a = 3I_0$ and $I_b = I_c = 0$. It is observed that corresponding drop in voltage of phase a while 'b' and 'c' voltages remain unchanged. Fault current is shown in fig 18.10. Fig 18.11 shows the computation of " $3V_0$ ". Fig 18.12 shows the appropriateness of $-3V_0$ as a reference phasor. " V_0 " is not present during normal conditions but available only during fault. Let the maximum torque be drawn at 60 degrees lag with respect to " $-3V_0$ " phasor.

It is then clear that zero torque line which separates the plane into operate and do not operate zone leads $-3V_0$ by 30 degrees. Thus, for fault in the correct region, $3I_0$ lags $-3V_0$ hence falls in operate region. If fault is behind the relay, $3I_0$ will lead $-3V_0$ by about 45 to 60 degrees and hence will lie in do not operate region. Hence, earth fault directional unit will not pick-up.

18.4.2 Current Polarization

An alternative to voltage polarization is current polarization. It does not require an additional VT. We briefly introduce its principle. When the system is balanced, $3I_0 = I_a + I_b + I_c = 0$. During ground fault say at phase 'a', at F_1 $3I_0$ flows from ground to neutral of a wye-delta power or distribution transformer bank. If we assume for simplicity that $I_b = I_c = 0$, then $3I_0$ and I_a are in phase. This indicates that directional unit for ground relay should pick-up as ' I_a ' is in phase with ' $3I_0$ '. Thus we place maximum torque line at zero degrees with respect to I_0 phasor. The corresponding trip, no trip relay are marked in fig 18.13. If however fault is behind the relay, then the I_a will fall in do not operate region and hence relay will not pickup as I_1^0 and I_{R1} will be in phase opposition.

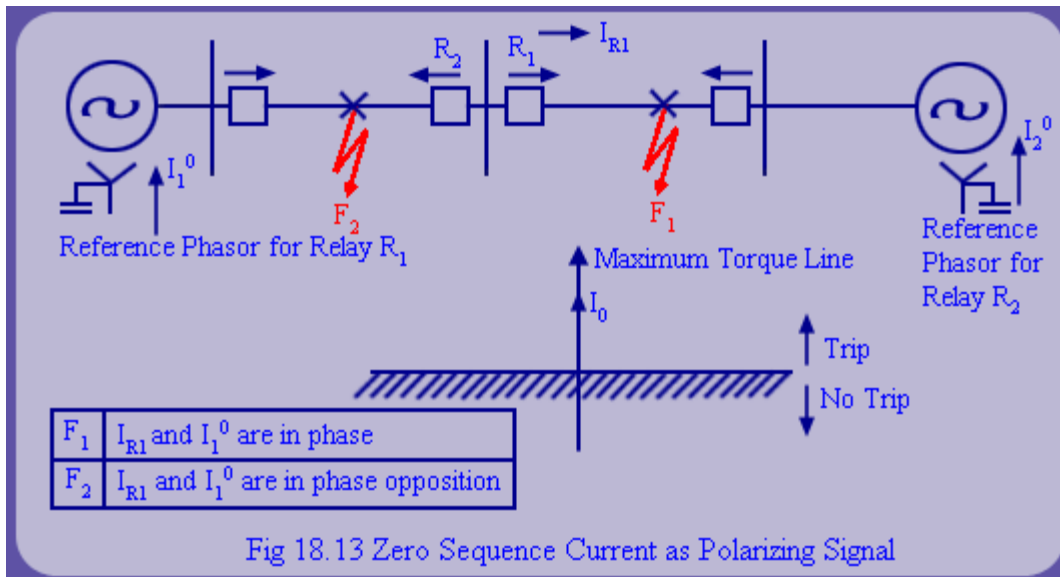

Review Questions

1. A single source system with parallel paths requires directional relays. Why?

2. What is meant by directional discrimination principle?
3. How is directional discrimination feature provided in 3 phase relays?
4. Earth fault relays in a multiple source system must be directional. Why?
5. What is a polarizing quantity? Differentiate between voltage polarization and current polarization.
6. Show that a 30° directional unit with V_{ab} as reference phasor will pick up on a - c and b - c phase faults.

Recap

In this lecture we have learnt the following:

- A system with multiple sources or parallel paths requires directional relays.
- Directional feature can be incorporated in an overcurrent relay and it improves its selectivity.
- A 30° directional unit with V_{bc} as reference phasor will pick up on a - b and a - c phase faults.
- Directional earth fault relays using voltage and current as polarizing quantity.