

Module 10 : Differential Protection of Bus, Transformer and Generator

Lecture 39 : Transformer Protection

Introduction

Differential protection of transformer was introduced in lecture 2. Traditionally, it involves establishing circulating current through a pair of matched CTs installed on the primary and secondary winding of the transformer. If there is no internal fault in the transformer, zero current flows through the differential overcurrent element. However, in case of an internal fault, the CT secondary currents are not matched and hence the differential current i_d is not zero. This causes the overcurrent element to pick up and operate the circuit breakers to isolate the transformer.

Selection of CT Turns Ratio

Let the transformer turns ratio given by $N_1 : N_2$ and the corresponding CT ratio be given by $1 : n_1$ and $1 : n_2$ as given in fig 39.1. Then,

$$\text{Current in CT - 1 primary} = I_1$$

$$\text{Current in CT - 1 secondary} = \frac{I_1}{n_1}$$

$$\text{Current in CT - 2 primary} = \frac{N_1 I_1}{N_2}$$

$$\text{Current in CT - 2 secondary} = \frac{N_1 I_1}{N_2 n_2}$$

If there is no fault, then with proper connections account for the CT polarity, we should obtain circulatory current through CT secondary.

$$\text{Hence, } i_1 = i_2$$

Selection of CT Turns Ratio (contd..)

$$\text{i.e., } \frac{I_1}{n_1} = \frac{N_1 I_1}{N_2 n_2} \text{ or } N_2 n_2 = N_1 n_1 \tag{1}$$

If the transformer (to be protected) is working on tap T as shown in fig 39.2, then the above equality has to be modified as follows:

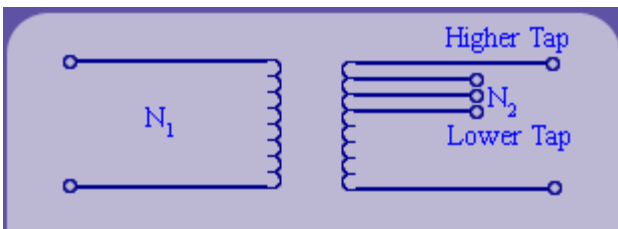

Fig 39.2 OFF Nominal Tap Setting of Transformer

$$N_1 n_1 = N_2 n_2 T \tag{2}$$

Example

Let the primary of the transformer winding has 1000 turns while secondary has 500 turns. If the primary CT ratio is 100:5, find the CT ratio required in the secondary side to establish circulatory current scheme.

Ans: $N_1 = 1000$, $N_2 = 500$ and $n_1 = 20$

From equation (1), we get

$$n_2 = \frac{N_1 n_1}{N_2} = \frac{1000 \times 20}{500} = 40$$

Thus, a suitable secondary CT ratio would be 200:5.

Example (contd..)

Remarks 1: Sometimes due to 'odd turns ratio' involved in primary, it may not be possible to obtain matching CTs on the secondary. In such situations 'auxiliary CTs' are used either on primary or secondary (or both sides) to obtain circulatory currents in absence of internal faults. Primary of the auxiliary CT is connected in series with secondary of main CT. Secondary of auxiliary CT participates in the circulating current scheme.

Remark 2: The circulating current scheme described above has been traditionally used with electromechanical and solid state relays. However in case of numerical relays, such physical connections are no more required. Given turns ratio $N_1 : N_2$ and CTs ratio $1 : n_1$ and $1 : n_2$, one can work out the expected current in secondary of transformer (in absence of internal fault). Hence, auxiliary CTs become redundant and the transformer connections are simplified drastically. Thus, with numerical relaying most of the hardware connections and circulatory currents can be easily accounted in software. Further, with digital protection systems differential protection can be implemented by either 'sample by sample' comparison or by first computing the phasors and then comparing them.

Phasor computation approach will involve a delay equal to the time required for moving window to latch on to post fault phasor. Conversely, 'sample by sample' comparison approach can be faster but it is more prone to picking up to noise or transients. Hence, even it has to be slowed down by 'polling scheme'. In this scheme, we increment a counter, whenever large enough differential is detected. If counter is positive and differential is below threshold, we decrement the counter. If the counter 'ensures' a threshold, a trip decision is issued.

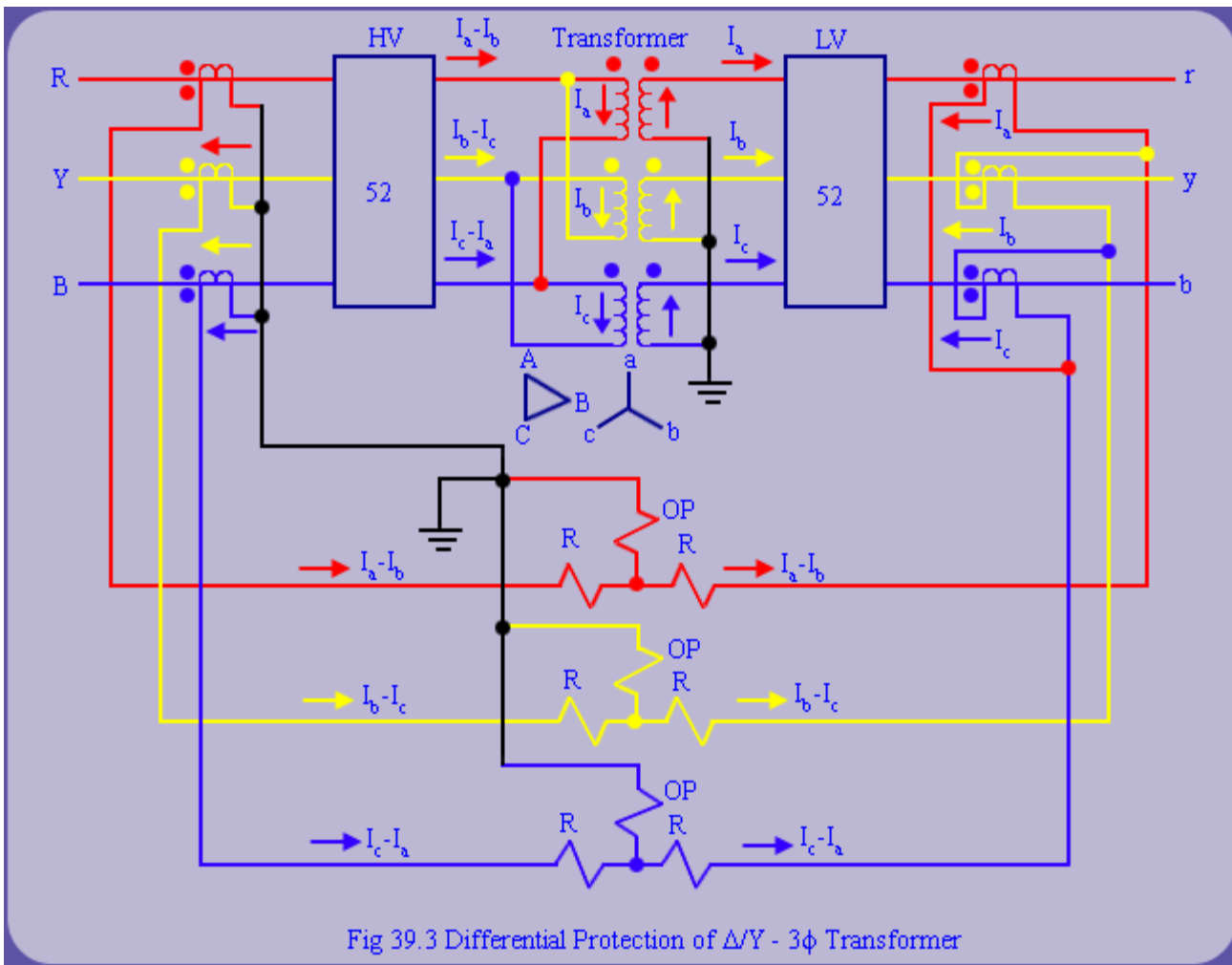

Example (contd..)

Remark 3: When dealing with three phase transformers, the transformer connections like Y-Y or $\bar{Y} - \Delta$ also play a role in determining CT secondary interconnections to establish circulating current scheme. This is because of the phase shifts typically of the order of $\pm 30^\circ$ that result in the line currents when we move from primary to secondary side of the power transformer. Fig 39.3 shows the typical connections for star-delta transformer bank for establishing the circulatory currents. The study of the circuit brings out the following important rule for interconnection of CT secondary for Δ/Y transformers: "If the power transformer winding are connected in Y configuration, use Δ configuration for corresponding CT secondary interconnections" (and vice-versa).

Remark 4: With numerical relays such interconnection complexity can be easily handled in software. After, specifying the turns ratio and the phase shift from primary to secondary, it should be possible to work out the expected secondary differential current by simple calculation.

Role of Percentage Differential Protection

So far, our discussion has focused on an ideal transformer. However, practical transformers and CTs pose additional challenge to protection.

- (1) The primary of transformer will carry no load current even when the secondary is open circuited. This will lead to

differential current on which the protection scheme should not operate.

- (2) It is not possible to exactly match the CT ratio as per equation (1). This would also lead to differential currents under

healthy conditions.

- (3) If the transformer is used with an off nominal tap, then differential currents will arise as equation (2) is not satisfied

even under healthy conditions. However, tap position can be read in numerical protection scheme and accounted by equation (2). This would make the numerical protection scheme adaptive.

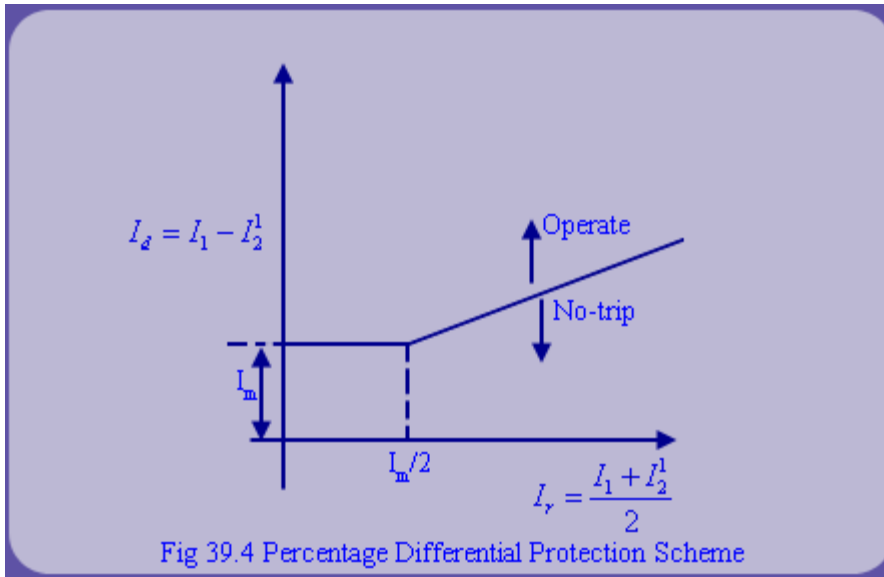

To prevent the differential protection scheme from picking up under such conditions, a percentage differential protection scheme is used. (see fig 39.4)

It improves security at the cost of sensitivity. Notice an offset of I_m to account for the no load current. The current on the x-axis is the average current of primary and secondary winding referred to primary. It indicates the restraining current while the corresponding difference on Y-axis represents the differential current. For reference current direction see fig 39.1.

The differential protection will pick up if magnitude of differential current is more than a fixed percentage of the restraining current.

Complications of Magnetizing Inrush

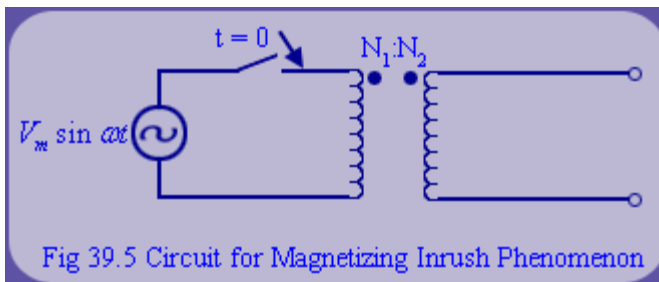

We now plan to show that even percentage differential protection scheme will misclassify the inrush current as fault current. This is because during inrush, secondary current is negligible (zero if secondary is open circuited), while primary current can be as high as 10 - 20 times the full load current. Thus some kind of restraint function is required to inhibit the pick up on inrush. Traditionally, this restraint is based upon second harmonic content in primary which discriminates a fault from the inrush condition.

Alternatives in numerical relaying also include voltage restraint used in integrated substation protection scheme and flux restraint scheme. Before, discussing these schemes further, we will review the origin of magnetizing inrush phenomenon.

Consider the circuit in fig 39.5. The switch is closed at $t = 0$. By Faraday's law, we have

$$V_m \sin \omega t = \frac{d\lambda_1}{dt}, \text{ with } \lambda_1 = N_1 \phi_m$$

$$\int_0^t d\lambda_1 = \frac{V_m}{\omega} \int_0^t \sin \omega t d(\omega t)$$

$$\lambda_1(t) - \lambda_1(0) = \frac{V_m}{\omega} [1 - \cos \omega t]$$

$$\phi(t) = \frac{V_m}{N_1 \omega} [1 - \cos \omega t] + \phi(0) \text{ and}$$

$$\phi_{\max} = \frac{2V_m}{N_1 \omega} + \phi(0)$$

(3)

Complications of Magnetizing Inrush (contd..)

For simplicity, let us assume that $\phi(0) = 0$. i.e. core is initially demagnetized. Then, the post energisation flux wave form in the core is shown in fig 39.6.

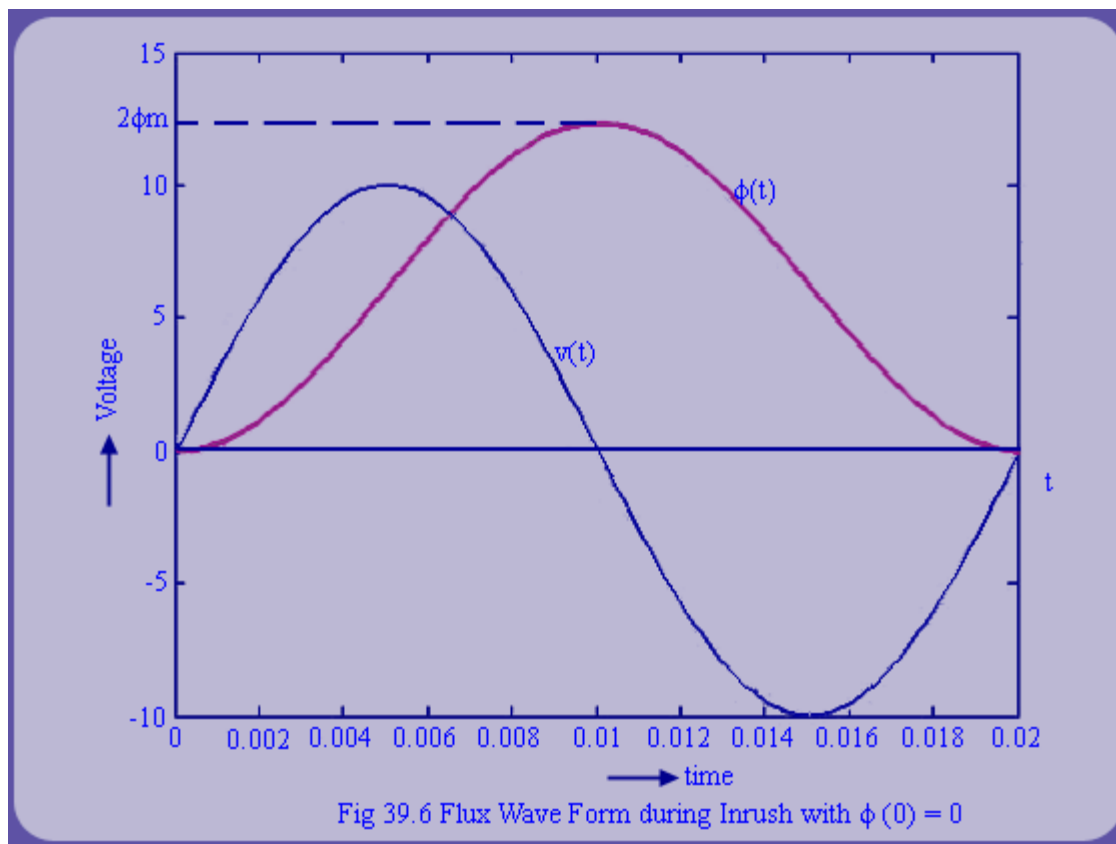

Complications of Magnetizing Inrush (contd..)

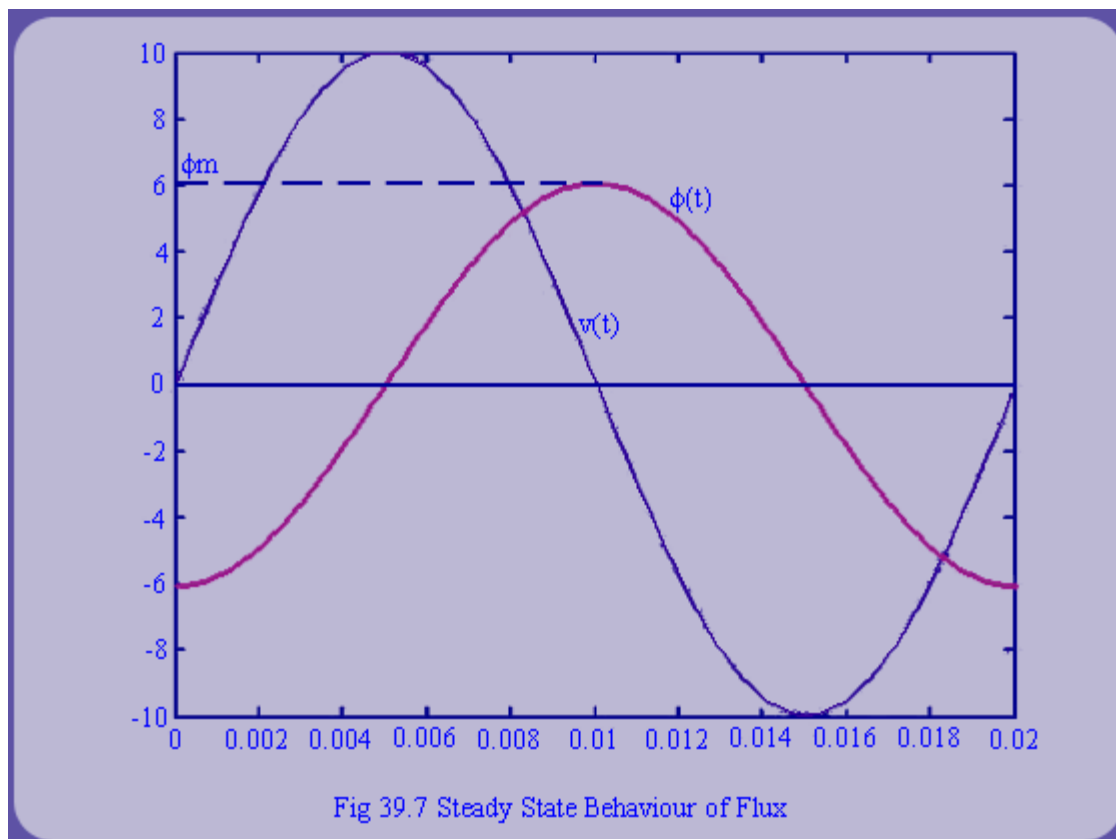

This wave form is quite different from what we obtain by steady state analysis as shown in fig 39.7. During steady state analysis, we can replace $\frac{d}{dt}$ by $j\omega$ and the corresponding steady state phasor equation is given as follows:

$$\bar{V}_1 = j\omega N_1 \bar{\phi}$$

i.e, $\bar{\phi} = \frac{\bar{V}_1}{j\omega N_1}$

$$\phi_m = \frac{V_m}{\omega N_1} \text{ and } \phi(t) = \phi_m \sin(\omega t - \frac{\pi}{2}) \tag{4}$$

Complications of Magnetizing Inrush (contd..)

Thus, it is clear that peak flux during energization is twice as high as the steady state peak sinusoidal value. Depending upon the residual flux, it can be even higher. Now, $A = \frac{\phi_m}{B_{knee}}$, where B_{knee} is the knee

point flux density of core. Thus, during energization, the core is driven deep into saturation. The resulting H and hence magnetizing current can be very high (up to 20 times full load current). This current is known as inrush current of transformer. So far, we have assumed $\phi(0) = 0$. But in general, $\phi(0)$ depends upon the remnant flux in the core and H can be anywhere between $-\phi_m$ and $+\phi_m$. Hence, ϕ_{max} during energization will vary from ϕ_m to $3\phi_m$. Fig 39.8 visualizes the nature of the inrush current.

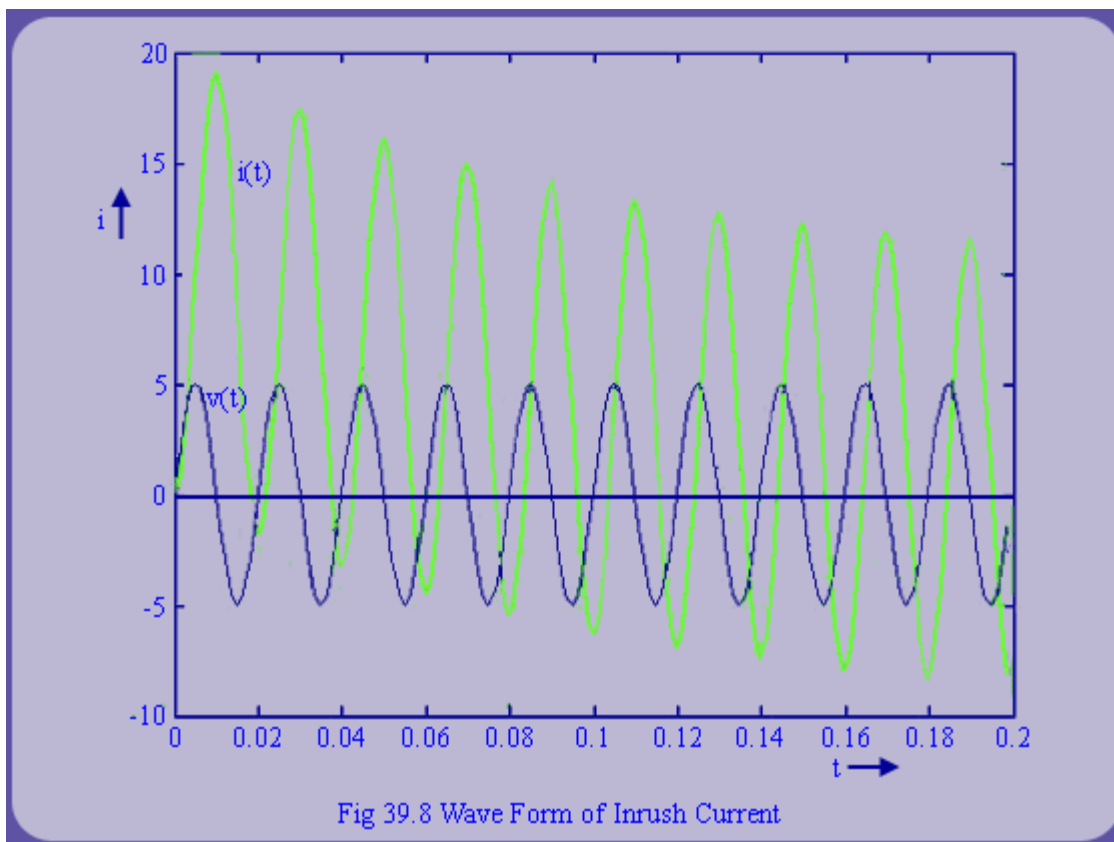

Fig 39.8 Wave Form of Inrush Current

Complications of Magnetizing Inrush (contd..)

Our analysis so has a discrepancy. As per our analysis, flux and current wave shape in fig 39.6 should persist till infinity i.e. it should represent the steady state flux and current waveform in the core. However, we also know that steady state flux and current waveform is as per fig 39.7. The resulting discrepancy is a consequence of our simplifying assumption viz, core is ideal and the winding is non resistive. If we also model the winding resistance, we would observe that the voltage available at the ideal transformer primary terminals would reduce drastically due to large voltage drop in the winding impedance during inrush condition. Consequently, the effect should propagate and reduce flux in the core. If the flux in the core reduces, so would magnetizing current. Thus, each cycle would have smaller

magnetization current peak and the magnetizing current and flux would finally approach the one produced by steady state phasor equation.

To summarize the discussion so far,

1. Transformer when energized can be subjected to large inrush currents.
2. Inrush current can trip differential protection of transformers.

Some methodology to detect inrush has to be devised and transformer differential protection has to be inhibited from tripping during this condition.

Detection of Inrush Current and Overexcitation Condition

Appreciable differential current can result due to either inrush or overexcitation of transformer. When a transformer is overexcited, then from the relationship $V_1 = N_1 4.44 f \phi_m$, we can infer that peak sinusoidal flux is large. This implies that transformer core will be driven into saturation for an interval in each half cycle. Due to this, there would be distortion from the sinusoidal magnetization current. During saturation, the corresponding magnetizing current can be quite large and on the resulting differential the protection system may issue a trip decision by confusing overexcitation for an internal fault. Hence, in practice restraint has to be provided for both overexcitation and inrush current condition. There are three possible ways in which this can be achieved.

(1) Harmonic Restraint

Analysis of the current waveform indicates that inrush current is rich in second harmonic and current during overfluxing has a large fifth harmonic component. Thus, if we compute the second and fifth harmonic current in $I_d = I_1 - I_2$, then, we can provide following logic for restraining operation of differential protection. Restrain operation of differential protection if

1. $|I_1 - I_2| < \alpha$ for restrain (No load magnetization current)

or

$$2. \left| \frac{I_1 - I_2}{2} \right| < \beta \left| \frac{I_1 + I_2}{2} \right|$$

(Where β is the slope of the % differential characteristics)

Detection of Inrush Current and Overexcitation Condition (contd..)

(1) Harmonic Restraint (contd..)

3. $|I_{dH2}| > \gamma I_d$ [For restraining inrush current]

(Where I_{dH2} is the magnitude of second harmonic)

or

4. $|I_{dH5}| > \delta |I_d|$ [For restraining overexcitation]

(Where I_{dH5} is the magnitude of fifth harmonic)

Typically, δ and γ are the percentage harmonic restraint and would depend upon type of transformer and steel. For numerical relays, the design of anti aliasing filters also affects the choice of above parameters. During any transient (including the fault condition), harmonics develop much more rapidly than the fundamental and hence, typically numerical relays are restrained for about a cycle indirectly by these transients. Typical setting for γ used in practice are 10, 20 or 30%.

(2) Voltage Based Restraint

In an integrated substation protection system, it is reasonable to assume availability of bus voltage measurement for transformer protection without extra cost of VT. Then, voltage measurement can be

used to restrain the operation of differential protection scheme on inrush or overexcitation. Traditionally, this has been referred in literature as “tripping suppressor” as it suppresses tripping function. If the voltage signal is high, the relay is restrained if

$$|I_d| < \alpha \text{ or} \tag{5}$$

$$|I_d| < \beta |I_r| \tag{6}$$

$$|V| > \sigma \text{ or} \tag{7}$$

$$|t_v| > p \tag{8}$$

Detection of Inrush Current and Overexcitation Condition (contd..)

(2) **Voltage Based Restraint (contd..)**

Expressions 5, 6 and 7 are self explanatory.

The last restraining function t_v is known as the transient monitor function. The transient monitor function is used to qualify the purity of data. Typically, in a numerical relaying set up, with moving window algorithm, there are a certain number of windows in which both pre fault and post fault data points are present. Any phasor computation done with them is meaningless because the window does not fit with either pre-fault or post-fault signal. Under such condition, the residual error r_k (i^{th} sample) between estimated (reconstructed) and measured signal is quite high. For a half cycle window with 6 samples in it, $t_v = \sum_{k=1}^6 |r_k|$. When t_v is greater than threshold value η , then tripping decision should be inhibited.

(3) **Flux Restraint Scheme**

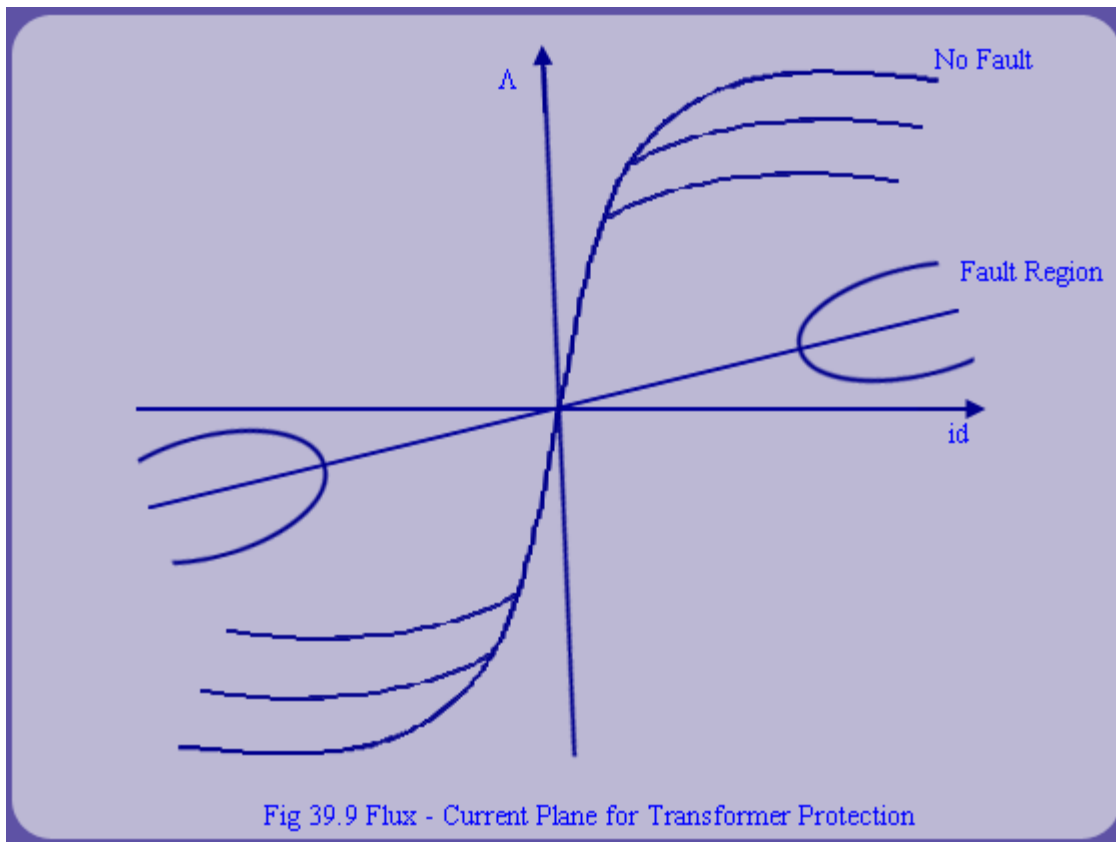

Fig 39.9 shows the flux current plane associated with no fault and internal fault regions. It is difficult to evaluate the actual flux in the core, because the initial condition is unknown. It depends also upon the remanent flux. Fortunately, to distinguish no fault (or external fault) from the internal fault, we are

interested in the slope of $\Lambda - i_d$ curve rather than the actual values.

Detection of Inrush Current and Overexcitation Condition (contd..)

(3) Flux Restraint Scheme (contd..)

This can be easily worked out as follows.

Let the voltage at the terminal of the transformer be $v(t)$, current $i(t)$ and let L be the leakage inductance of the winding. If we neglect the resistance of the winding, then,

$$v(t) - L \frac{di(t)}{dt} = \frac{d\Lambda(t)}{dt}$$

$$\Lambda(t_2) - \Lambda(t_1) = \int_{t_1}^{t_2} v(t) dt - L[i(t_2) - i(t_1)]$$

Using trapezoidal rule of integration, we get

$$\Lambda(t_2) - \Lambda(t_1) = \frac{v(t_2) + v(t_1)}{2} \Delta t - L[i(t_2) - i(t_1)] \quad (9)$$

From the above equation (9) we can deduce the following generic relationship.

$$\left(\frac{d\Lambda}{di} \right)_k = \frac{\Lambda_k - \Lambda_{k-1}}{i_k - i_{k-1}} = \frac{\Delta t}{2} \left[\frac{v_k + v_{k-1}}{i_k - i_{k-1}} \right] - L \quad (10)$$

Operation on the unsaturated region of magnetizing curve produces large value of slope $\frac{d\Lambda}{di}$. Since, the

fault or overexcitation (saturated) regions have smaller $\left(\frac{d\Lambda}{di} \right)_k$ slopes, we can now distinguish internal fault from the saturation condition by following counter scheme.

If current differential indicates trip and $\left(\frac{d\Lambda}{di} \right)_k < \xi$, increment counter.

$$k_y = k_y + 1$$

else if $k_y > 0$ and $\left(\frac{d\Lambda}{di} \right)_k > \xi$, then

$$k_y = k_y - 1$$

else if $k_y = 0$ and $\left(\frac{d\Lambda}{di} \right)_k > \xi$, then

$$k_y = 0$$

If there is an internal fault in the system, then k_y will monotonically increase and once k_y crosses a known threshold, trip decision will be issued. On the other hand, during inrush or over excitation the $\frac{d\Lambda}{di}$ will alternate between low slope and high slope region depending upon whether the core is in saturation or not. Thus, the counter k_y will indicate a small tooth kind of behavior with k_y^{\max} being below the threshold value. Hence, operation of the different protection scheme would be restrained in this region.

Remark 5: We have illustrated the basic principle so far using a single phase transformer for simplicity. However, in practice, we use both three phase two winding and three phase three winding (primary, secondary and tertiary) transformers. The basic principle of differential protection is the same but we now have to scale up to multiple phases. For a three phase (two winding) transformer, there would be 3 trip currents (one per phase) and three restraining currents (one per phase). For three phase three winding transformers, two restraining per phase are required.

Review Questions

1. What are auxiliary CTs? Why are they used?
2. What are the advantage of numerical relaying over other relaying schemes in differential protection?
3. Show that maximum flux during energization can vary from ϕ_m to $3 \phi_m$.
4. What are the various restraint schemes used?
5. The primary winding of a transformer has 2000 turns and CT ratio is 600:5. The secondary has 10000 turns and is working on a tap of 60%. Find out CT ratio required for secondary side to establish circulating current scheme.
6. Explain how reliability is obtained by polling scheme in the 'sample by sample' comparison approach for differential protection.

Recap

In this lecture we have learnt the following:

- How to select CT turns ratio for differential protection application.
- Percentage differential protection.
- Magnetizing inrush current and its complications.
- Detection of inrush current and overexcitation current.
- Different restraint schemes in use.
- Applications to 3 phase transformers.

